



Model 122X MiniPrinter Series



User's Manual

UNITED STATES

This equipment has been tested and found to comply with the limits for a Class A digital device, pursuant to Part 15 of the FCC Rules. These limits are designed to provide reasonable protection against harmful interference when the equipment is operated in a commercial environment. This equipment generates, uses, and can radiate radio frequency energy and, if not installed and used in accordance with the instruction manual, may cause harmful interference to radio communications. Operation of this equipment in a residential area is likely to cause harmful interference in which case the user will be required to correct the interference at his own expense.

CANADA

This digital apparatus does not exceed the Class A limits for radio noise emissions from digital apparatus set out in the Radio Interference Regulations of the Canadian Department of Communications.

Le present appareil numerique n'emet pas de bruits radioelectriques depassant les limites applicables aux appareils numeriques de la Class A prescrites dans le Reglement sur le brouillage radioelectrique que edicte par le ministere des Communications du Canada.



CAUTION

Risk of electrical shock. Do not remove cover. No user serviceable parts inside. Refer servicing to qualified service personnel.

Weigh-Tronix reserves the right to change specifications at any time.

Table of Contents

Specifications	4
Introduction	6
Installation	6
Installing the Paper	6
To Remove the Paper Roll	9
Operation	10
Connecting and Powering up Your Printer	10
Maintenance	10
Changing the Printer Ribbon	11
Inserting a Ribbon with Paper in the Printer	12
Printer Test and Setup	13
Printer Test	13
Accessing the Setup Menu	14
CONFIGURE	14
CUSTOM	17
SET CLOCK...	19
RESET SEQ#	20
Communication	21
Model 1220 RS-232 Serial Version	21
Model 1221 Parallel Version	23
Model 1222 Serial TTL Version	25
Model 1223 20 mA Current Loop Version	26
Model 1224 RS-485 Serial Version	27
Control Codes	29
Default Table	38

Specifications

Interface-Serial	<p><i>Available baud rates:</i> 300, 600, 1200, 2400, 4800, 9600, 19200</p> <p><i>Voltage levels:</i> RS-232C: -9 Volts to + 9 Volts TTL: 0 Volts to + 5 Volts 20mA current loop RS-485: 200mV differential</p> <p><i>Character format:</i> Standard ASCII character set—10 or 11 bits per character, 7 or 8 data bits. Even or odd parity selection for 7 data bits. Bit mapped graphics—10 bits per character required Busy signal - Clear to Send (CTS) or XON-XOFF</p>
Interface-Parallel	36-pin Centronics
Character Buffering	<p>1.5K standard 8K optional</p> <p>Approximately 9500 byte capacity with option installed.</p>
Print Method	Impact dot matrix
Character Matrix	5 x 8 or 5 x 5
Character Spacing	<p>24 column: 12.8 characters/inch 32 column: 17 characters/inch 40 column: 21 characters/inch</p>
Line Feed Spacing	<p>7.6 lines per inch, character mode 9.1 lines per inch, graphic mode</p>
Print Speed	<p>38 lines per minute for 24 column 33 lines per minute for 32 and 40 column</p>
Paper	<p>Table top: 2.25"W x 2.75"D; 0.44" I.D. Panel mount: 2.25"W x 1.25"D</p>
Power	1 Watts (idle), 10 Watts (while printing)
AC Voltage	9 VAC (120 VAC stepdown converter included) Multi-national converters optional
DC Voltage	<p>Optional 9-12 VDC 100mA idle, 1500mA with 100% printing, 2.9A peak with 100% printing</p>
External Dimensions	4.1"W x 4.5"L x 2"H
Operating Temp.	5°C to 40°C, 41°F to 104°F

Print Head Life	500,000 lines mean character before failure.
Ribbon Life	Black- 200,000 characters Purple- 250,000 characters
Paper	Large roll - 12,500 lines Small roll - 3,000 lines

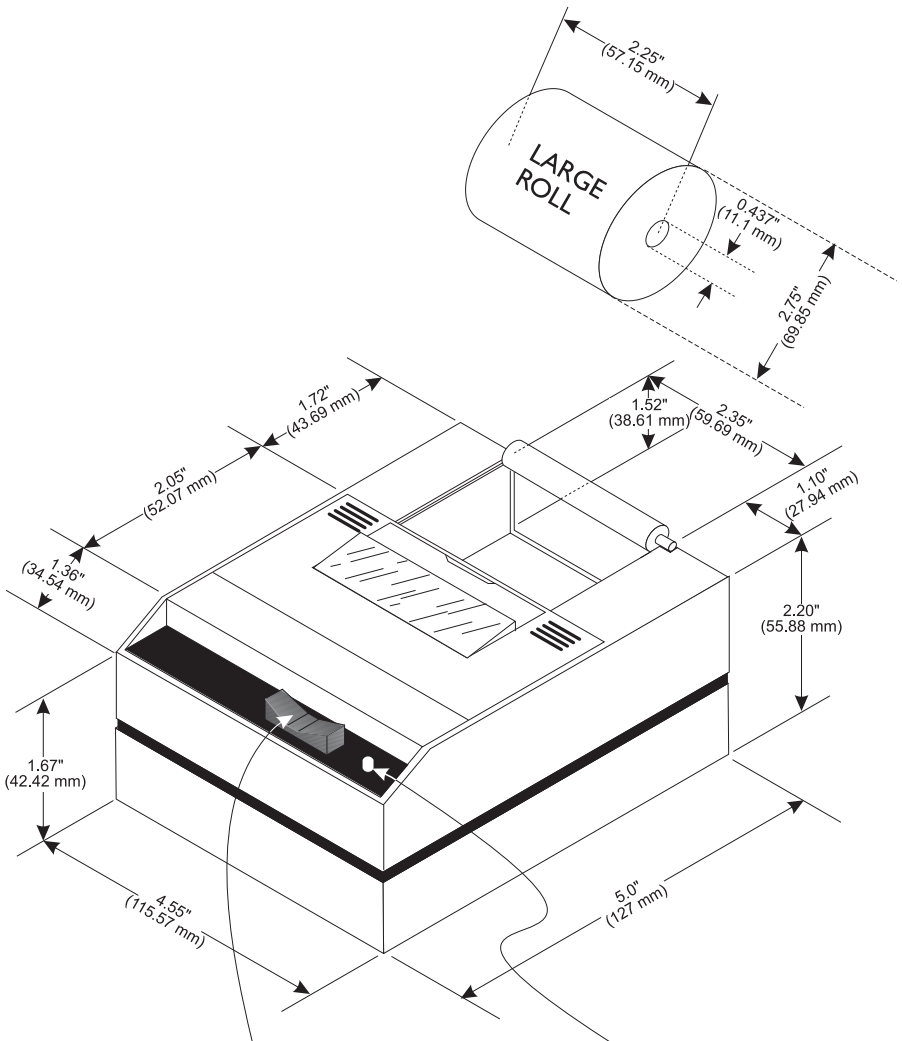

Rocker Switch
 Left side - Toggles printer on and offline
 Right side - Paper Feed

Ready Indicator

Introduction

The Model 122X impact printer series consists of these models and electronic interfaces:

Model 1220 - RS-232

Model 1221 - Parallel

Model 1222 - TTL

Model 1223 - Current Loop

Model 1224 - RS-485

This manual is split into the following main sections:

- Introduction
- Installation
- Operation
- Maintenance
- Printer Test and Setup
- Communication
- Default Settings

Installation

Follow the precautions listed below when setting up your printer. They are designed to help you keep your printer working at its best.

- Plug your power supply into an appropriate grounded outlet.
- Place your printer on a flat hard surface, like a tabletop.
- Keep your printer out of direct sunlight.

Installing the Paper

1. Remove the printer cover by pressing on the groove patterns to pop the front edge up. Lift off the cover.
2. Press the rocker switch to the left. The light will go off.
3. Unroll several inches of the paper.

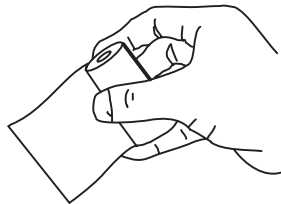

4. Cut a straight edge on the paper roll if it is jagged. This will facilitate the entry of the paper into the printer.
5. Slide the paper through the slot connecting the paper compartment and the printer compartment. You can slide it in about one-quarter inch before it stops.

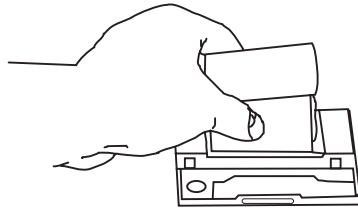
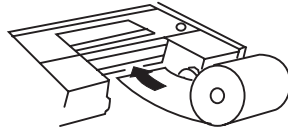

6. While holding the paper in place, press the rocker switch to the Paper Feed position. The printer will activate, and a rubber roller will pull the paper into the printer compartment. Hold the switch in the Paper Feed position until the paper emerges from the top of the printer mechanism.
7. When an inch of paper has emerged from the top of the printer, release the Paper Feed button.
8. Now pull the paper through the printer, until several inches are exposed.

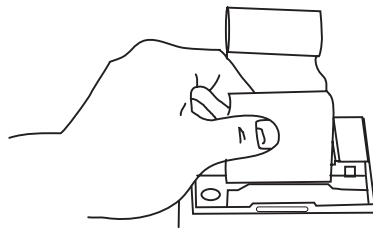

9. Slide the paper through the slot in the printer cover.

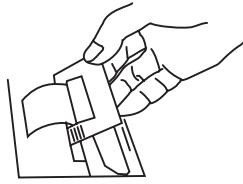

10. Push the back of the printer cover down and into place.

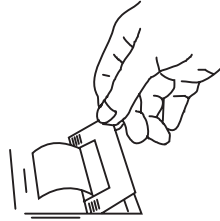

11. Press the front of the printer cover down to lock in place.

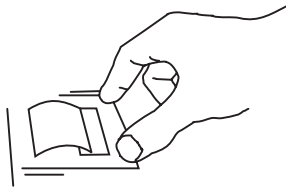

12. Put the paper spindle into the paper roll as shown below, and place the roll with the spindle onto the snaps near the back of the printer. Turn the paper roll to take up any slack in the paper feeding to the printer. Make sure the roll of paper turns freely. If it does not turn freely, the paper will jam and will possibly damage the printer mechanism.

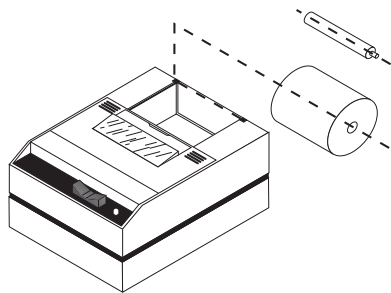

To Remove the
Paper Roll



Warning

Pulling the paper out of the back of the printer will damage the print mechanism.

1. Advance the paper about one inch beyond the paper cutter by using the Paper Feed switch.
2. Lift the paper roll away from the printer housing and cut the paper feeding to the printer with scissors. Try to make the cut as square as possible to help the next time you reload the paper.
3. Pull the remaining paper through the printer mechanism. **Be sure to pull the paper from the top** (paper cutter side).

Operation

Connecting and Powering Up Your Printer

For DC modified units supplied with cable, connect positive voltage to striped wire.

See the DC power connection illustration below:



1. Attach the appropriate cable between the printer and your host device. The connector on the printer side is “keyed” so that you cannot plug the cable in the wrong way. This means that the pins should be positioned so that a slight pressure will seat the cable properly. Do not force the pins in. Doing so could damage the cable.
2. Plug the power cord into the back of the printer. Plug the transformer into an appropriate AC outlet. The unit will power up automatically and print **Ready**. This means the printer is ready to print.

The Paper Feed switch on the printer is a rocker type switch. Push the left side of the rocker switch to toggle the printer on and offline. Push the right side of the switch to advance the paper.

Your printer is now ready for printing.

The printer stores characters for printing until one of two things happens:

1. Its line buffer is filled.
2. It receives a line feed (hexadecimal 0A) or a carriage return (hexadecimal 0D) code.

When (1) or (2) occurs, the printer prints out the contents of its line buffer. If the buffer is empty when the carriage return is received, the printer simply advances the paper one line, leaving a blank line in the printout.

Maintenance

NCI Part Numbers:

Black ribbon:	22332-0029
Purple:	22332-0011
Long-lasting Black:	22332-0045
Wall mount power:	114815534
Paper spindle:	109316536
Paper roll 1.25" dia:	22335-0018
Paper roll 2.75" dia:	22335-0026
Almond paper cutter	23019-0019
Grey paper cutter	23019-0043
Clear plastic paper roll cover	115513184

When printing becomes faint or difficult to see, replace the ribbon in your printer with an Epson ERC-09 cartridge ribbon.



Changing the Printer Ribbon

If your printer is used infrequently, the print impression may become weak because the ribbon has dried out. To advance the ribbon to a new section, hold down the Paper Feed switch for several seconds.

Below are the steps for replacing the ribbon:

1. Turn the printer offline.
2. Four small grooves are embossed on each side of the printer cover. Push down on one or both of these areas until the printer cover tilts.

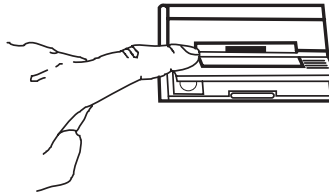
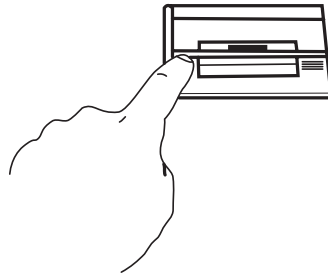

3. When the printer cover is tilted up, lift it completely off.
4. Push down on the right side of ribbon cartridge where it is marked "PUSH". Remove the cartridge.

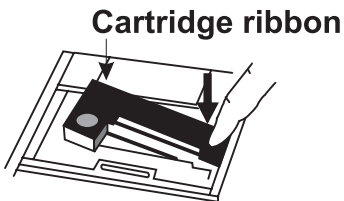

5. Install new cartridge. Be sure the ink cartridge is inserted firmly to prevent weak or irregular printing. The cartridge must be properly seated and aligned for best printing.

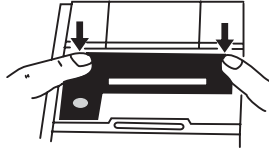

6. Turn the cartridge "knob" (marked by an arrow) clockwise to stretch the ribbon.

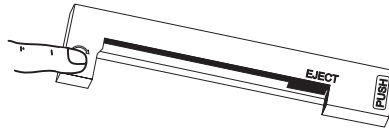

If you get ribbon ink on the printer case, wipe it off immediately. Once it dries it is difficult to remove.

7. Replace the cover.
8. Replace the paper.

You may insert the ribbon cartridge if there is already paper in the printer.

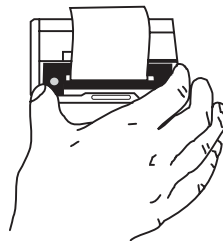

Hold the cartridge as shown above and slide it over the paper and into the printer compartment. Be sure the paper goes between the ribbon cartridge and the ink ribbon.

Printer Test and Setup

Printer Test

The printer can be tested and setup using the steps described in this section. Testing and setup are done using the rocker switch on the printer.

With the printer unplugged at the outlet or at the back of the printer, press and hold the right side of switch as you plug the unit in. The printer will print out a list of the configuration as it currently exists then do a continuous print test. To stop the print test, press either side of the rocker switch. Below is a sample of what is printed when you do the print test.

T & D will be printed in the list to the right if the Time and Date option is installed.

```
*****  
** PRINTER TEST **  
Serial Version B122XL  
  
BAUD=1200  
DATA BITS=8  
PARITY=NONE  
STOP BITS=1  
HSHAKE=BUSY-BUFF  
COLS=32  
FONT=5x8  
INVERT=NO  
MAG=NONE  
BUFFER: 1.5K  
INT RAM: OK  
ROM: OK  
EEPROM: OK  
! " # $ % ' ( ) * + , - . / 0 1 2 3 4 5 6 7 8 9 : ; < = > ? @  
" # $ % ' ( ) * + , - . / 0 1 2 3 4 5 6 7 8 9 : ; < = > ? @ A  
# $ % ' ( ) * + , - . / 0 1 2 3 4 5 6 7 8 9 : ; < = > ? @ A B  
$ % ' ( ) * + , - . / 0 1 2 3 4 5 6 7 8 9 : ; < = > ? @ A B C  
*****
```

Accessing the Setup Menu

This manual assumes the time and date option is installed and operating. If you do not have this option you will not see references to the clock or date listed in most menus.

To access the setup menu follow these steps:

1. Unplug the printer either at the outlet or at the back of the printer.
2. Press and hold down the left side of the rocker switch and plug in the printer. The printer will advance the paper. After the paper advance has stopped, count for 3 to 5 seconds and then release the switch. The following is printed:

```
*****  
*** SETUP MENU ***  
CONFIGURE...      [NEXT/OK]  
*****
```

If you wait less than three or more than five seconds **Ready** is printed and you will have to try steps 1 and 2 again to access the setup menu.

After you access the setup menu, if you press **NEXT** (left side of switch) repeatedly you will see the following list printed. If you keep pressing **NEXT** (left side) the list repeats itself.

```
*****  
*** SETUP MENU ***  
CONFIGURE...      [NEXT/OK]  
CUSTOM...         [NEXT/OK]  
SET CLOCK...      [NEXT/OK]  
RESET SEQ#...     [NEXT/OK]  
CONFIGURE...      [NEXT/OK]  
*****
```

As you can see from the above printout the setup menu contains the following items:

- **CONFIGURE** menu
- **CUSTOM** menu
- **SET CLOCK** menu
- **RESET SEQ#**

The following pages explain these items and how to customize the printer to your needs.

Configure

The first setup menu item reads

CONFIGURE [NEXT/OK]

[NEXT/OK] is a visual clue so you know that pressing the left side of the rocker switch will go to the **NEXT** part of the menu and that pressing the right side of the rocker switch will accept (or say **OK** to) what this line of the setup menu says.

With the printer in the setup menu and with **CONFIGURE [NEXT/OK]** as the last item printed, press **OK** (right side) to access the **CONFIGURE** menu. The following is printed:

```
*****  
*** SETUP MENU ***  
CONFIGURE... [NEXT/OK]  
*** CONFIGURATION MENU ***  
LOAD DEFAULTS [NEXT/OK]  
*****
```

Load Defaults

LOAD DEFAULTS gives you the opportunity to reset the printer to all default settings (shown below).

```
*****  
*** CONFIGURATION MENU ***  
LOAD DEFAULTS [NEXT/OK]  
* BAUD=1200 [NEXT/OK]  
* DATA BITS=8 [NEXT/OK]  
* STOP BITS=1 [NEXT/OK]  
* HSHAKE=BUSY-BUFF [NEXT/OK]  
COLS=32 [NEXT/OK]  
INVERT=NO [NEXT/OK]  
FONT=5x8 [NEXT/OK]  
MAG=NONE [NEXT/OK]  
Ready...  
*****
```

* The parallel interface does not have these selections.

The complete list of defaults is shown in the Default Table at the end of this manual.

Choose **OK** to do this or **NEXT** to go to the next parameter. The following is printed:

```
*****  
*** SETUP MENU ***  
CONFIGURE... [NEXT/OK]  
*** CONFIGURATION MENU ***  
LOAD DEFAULTS [NEXT/OK]  
BAUD=1200 [NEXT/OK]  
*****
```

Baud Rate

Baud rate is the next parameter you can set in the **CONFIGURE** menu. The complete list of parameters and their possible values is shown below.

The sample list above shows the current baud rate is 1200. To accept this, press **OK** (right side) or view the next baud rate value by pressing **NEXT** (left side). Press **OK** when the baud rate you want is displayed.

Choose from these baud rates;
300, 600, 1200, 2400, 4800, 9600, or 19200

Data Bits

DATA BITS is the next parameter. Choose the data bit value the same way baud rate was chosen. Choices are 7 or 8 data bits.

DOUBLE HIGH

DOUBLE HIGH

DOUBLE WIDE/HIGH

DOUBLE WIDE/HIGH

After you choose one of the magnifications the printer will print **Ready** to show the printer is out of the configuration menu and the setup menu and is ready to print.

CUSTOM

The next setup menu item after **CONFIGURE** is **CUSTOM**. With the printer in the setup menu and with **CUSTOM** as the last item printed, if you press OK (right side) the printer will print the following:

```
*****  
*** SETUP MENU ***  
CONFIGURE... [NEXT/OK]  
CUSTOM... [NEXT/OK]  
***** CUSTOM MENU *****  
PRINT CUSTOM SETUP [NEXT/OK]  
*****
```

If you press **OK** the printer will print the current custom setup. A sample is shown below.

```
*****  
** CUSTOM SETUP **  
CLOCK: INSTALLED  
CLOCK: NOT SET  
MM/DD/YY hh:mm ?M DOW  
AUTO T&D=NO  
AUTO SEQ=NO  
ZERO=0  
POUND SIGN=#  
_ (Underscore)  
BUSY INVERT=NO  
ONLINE/OFFLINE=YES  
EXT CH SET=NO  
PRINT READY=YES  
Ready...  
*****
```

This printout shows you how each item is currently set. Below is an explanation of each item and the choices you can make for each.

T/D Format	<p>TIME/DATE FORMAT is the next parameter. Choose from the following formats.</p> <p>MM/DD/YY hh:mm ?M MM/DD/YY hh:mm ?M DOW MM = month MM/DD/YY hh:mm DD = day MM/DD/YY hh:mm DOW YY = year DD-MM-YY hh:mm ?M hh = hour DD-MM-YY hh:mm ?M DOW mm = minutes DD-MM-YY hh:mm ?M = AM or PM DD-MM-YY hh:mm DOW DOW=Day of week DD-MON-YY hh:mm ?M DD-MON-YY hh:mm ?M DOW DD-MON-YY hh:mm DD-MON-YY hh:mm DOW NONE</p>
<p><i>This feature is available only on units with the time/date option installed.</i></p> <p><i>Time/date option is Y2K compatible.</i></p>	
Auto T&D	<p>AUTO TIME AND DATE is the next parameter. Your choices are:</p> <p>YES - autoprnt after CR (carriage return) NO - do not autoprnt after CR</p> <p>Autoprnt of the time and date will not occur unless three seconds has elapsed since the printer has stopped printing.</p>
<p><i>Appears only if the clock is installed.</i></p>	
Auto Seq#	<p>AUTO SEQUENCE NUMBER is the next parameter. Choices:</p> <p>YES - autoprnt sequence number after CR NO - don't autoprnt sequence number after CR</p> <p>Autoprnt of the sequence number will not occur unless three seconds has elapsed since the printer has stopped printing.</p>
Zero	<p>ZERO is the next parameter. Choose how you want the zero character to look in your printouts. Choose between 0 and Ø.</p>
Pound Sign	<p>POUND SIGN is the next parameter. Choose to show pound as # or as the British sterling pound symbol £.</p>
_Underscore	<p>_UNDERScore is the next parameter. Choose which symbol the same ASCII code will print, an underscore (_) or a left arrow (←).</p>
Busy Invert	<p>BUSY INVERT is next. This controls the logic level for a busy signal for the CTS line. Choices:</p> <p>YES - voltage will be in a low state until the unit is busy then voltage level goes high. NO - voltage will be in a high state until the unit is busy then voltage level goes low.</p>

Online/Offline

ONLINE/OFFLINE is next.

Choices:

YES - enables the rocker switch to turn the printer offline.

NO - disables the ONLINE/OFFLINE ability.

Ext Ch Set

EXT CH SET is next. This stands for Extended Character Set.

Choices:

YES - Allows you to use hexadecimal numbers above 80 (true only for 8 data bits.)

NO - Disables the Extended Character Set ability.

The choice to use the extended character set is available only when 8 data bits are chosen.

Print Ready

PRINT READY is next.

Choices:

YES - Prints **Ready** upon power up.

NO - Disables printing **Ready**



Warning

*If you choose **NO**, then you will need to hold the left side of the rocker switch down for 4 to 6 seconds to access the setup menu. Begin timing when you plug in power to the unit and the red light comes on. The paper feed motor does not run upon power up when **Ready** is disabled.*

SET CLOCK

The next item in the Setup Menu is **SET CLOCK**

With the printer in the setup menu and with **SET CLOCK** as the last item printed, if you press **OK** (right side) the printer will print the following:

```
~~~~~  
SET CLOCK... [NEXT/OK]  
*** SET DATE ***  
Set Year: 00..... [NEXT/OK]  
~~~~~
```

The printout shows the year currently in memory. The **0** is reversed (white on black) to show the position of the cursor. This is the number which will be incremented if **NEXT** (left side) is pressed. If the number is correct press **OK** (right side) and the following is printed:

```
~~~~~  
SET CLOCK... [NEXT/OK]  
*** SET DATE ***  
Set Year: 00..... [NEXT/OK]  
Set Year: 00..... [NEXT/OK]  
~~~~~
```

This feature is available only on units with the time/date option installed.

- DOW :
- 0=Sunday
 - 1=Monday
 - 2=Tuesday
 - 3=Wednesday
 - 4=Thursday
 - 5=Friday
 - 6=Saturday

The cursor now appears over the 2nd position. Press **NEXT** (left side) to increment this number if needed and **OK** if it is right. Continue this sequence of accepting or changing the year, month, day, and DOW (Day Of Week).

```
*****  
*** SETUP MENU ***  
CONFIGURE... [NEXT/OK]  
CUSTOM... [NEXT/OK]  
SET CLOCK... [NEXT/OK]  
*** SET DATE ***  
Set Year: 00.....[NEXT/OK]  
Set Year: 00.....[NEXT/OK]  
Set Mon: 01.....[NEXT/OK]  
Set Mon: 01.....[NEXT/OK]  
Set Day: 01.....[NEXT/OK]  
Set Day: 01.....[NEXT/OK]  
Set DOW: 1.....[NEXT/OK]
```

When you have completed the **SET DATE** menu the following is printed automatically:

```
*****  
*** SET TIME ***  
Set Hour: 10..... [NEXT/OK]
```

Choose **NEXT** (left side) to increment the number or **OK** (right side) to accept the 1. Repeat this same procedure for hours and minutes as shown below.

```
*****  
*** SET TIME ***  
Set Hour: 10..... [NEXT/OK]  
Set Hour: 10..... [NEXT/OK]  
Set Min: 05..... [NEXT/OK]  
Set Min: 05..... [NEXT/OK]  
Start Clock..... [OK]  
Ready...
```

RESET SEQ#

When everything is as you want it and you press **OK**, **START CLOCK** is printed. Press **OK** (right side) to start the clock. The printer then prints **Ready** showing you that it is out of the setup menu and ready to print.

RESET SEQ# is the last setup menu item. This menu item lets you reset the sequence number. This number is the number of print transactions since the last reset. With the printer in the setup menu and with **RESET SEQ#** as the last item printed, if you press **OK** (right side) the sequence number will be

reset to zero and the printer will print **Ready** and printer is ready to print.

To skip resetting the sequence number to zero, press **NEXT** (left side). **CONFIGURE** is printed. Unplug and replug in the printer to return to printing mode. **Ready** is printed.

Communication

Model 1220
RS-232 Serial Version

This section shows the cable differences in the models of the 1220 series printer and the control codes and communication protocols.

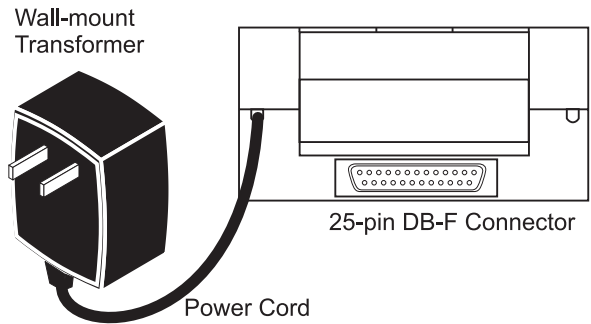

Pin No.	Signal	DTE Direction	Description
1	Chassis ground	-	Cable shield
2	(TD) Transmitted data	From printer	Printer data output line
3	(RD) Received data	To printer	Printer data input line
7	(SG) Signal ground	-	Signal ground
11	(CTS) Clear to send	From printer	Signal (equivalent to BUSY) indicating that printer is ready for operation and can receive data.
The rest are not used.			

Model 1220 (2600)
RS-232 Serial Version

Wall-mount
Transformer

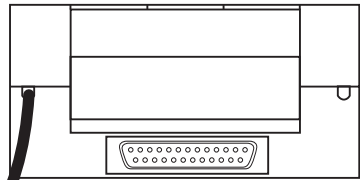
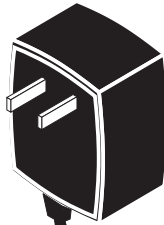

25-pin DB-F Connector

Power Cord

Pin No.	Signal	DTE Direction	Description
1	Chassis ground	–	Cable shield
2	(RD) Received data	To printer	Printer data input line
5	(CTS) Clear to send	From printer	Signal (equivalent to BUSY) indicating that printer is ready for operation and can receive data.
7	(SG) Signal	–	Signal Ground

The rest are not used.

Serial Interface Voltage Levels

Received data:

Mark = OFF = Logic "1" = -25V to -3V

Space = ON = Logic "0" = +25V to +3V

Clear to send:

Busy = OFF = Logic "1" = -9V

Not Busy = ON = Logic "0" = +9V

Transmitted data:

Mark = OFF = Logic "1" = -9V

Space = ON = Logic "0" = +9V

Model 1221
Parallel Version

Wall-mount
Transformer

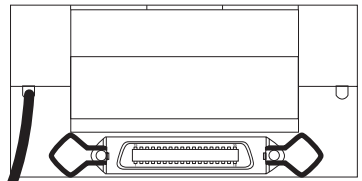
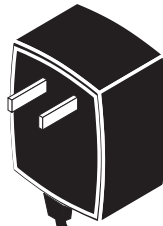

36-pin Centronics Connector

Power Cord

Pin No.	Signal	Direction	Description
1	Data Strobe	To printer	Samples input data when held low for 10 microseconds.
2	Data Bit 1	To printer	Indicates input data. High level indicates "1" and low level "0".
3	Data Bit 2		
4	Data Bit 3		
5	Data Bit 4		
6	Data Bit 5		
7	Data Bit 6		
8	Data Bit 7		
9	Data Bit 8		
10	Acknowledge	From printer	Indicates character input completion at low level.
11	BUSY	From printer	Indicates data cannot be received at high level.
16-29	0 Volts	-	Twisted pair return (For pins 1 to 11)
12	0 Volts	From printer	High = Out of paper.
13	+5v	From printer	High = printer selected.
32	+5v	From printer	Low level = Error condition.

The rest are not used.

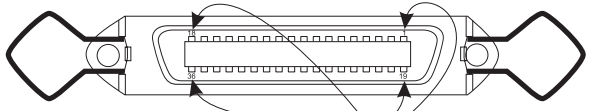

Parallel Connector Pin Arrangement

1. Connectors
 On the printer: 36-pin receptacle, equivalent to 57-40360-12-D56 AMP
 On the cable: 36-pin plug, equivalent to 57-30360 AMP or plug equivalent to 552274-1 AMP cover equivalent to 552073-1 AMP
2. Cable
 Use a cable less than 10 feet long. A shielded cable using twisted pair conductions is desirable.
3. Connector Locks
 After engaging the connectors, fasten them with locks.

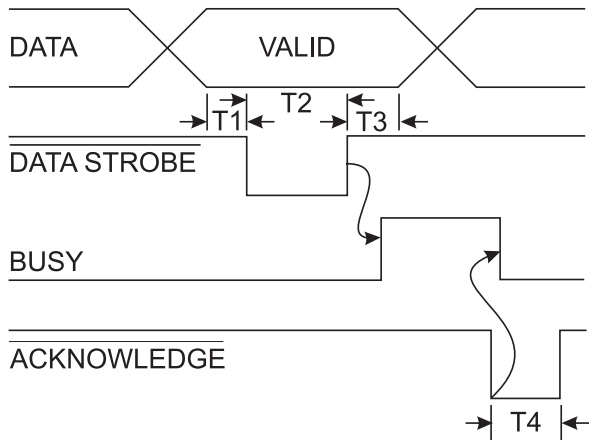

- T1 = 0 minimum
- T2 = 0.5 microseconds minimum
- T3 = 1 microsecond minimum
- T4 = Approx. 6.8 microseconds

Model 1222
Serial TTL Version

Wall-mount
transformer

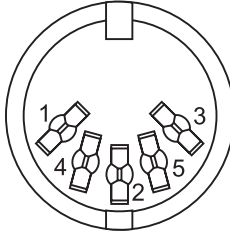
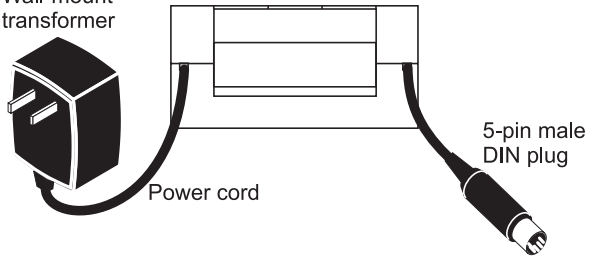

Pin No.	Type
1	BUSY
2	GROUND
3	RCV. DATA
4	XMT DATA
5	NOT USED

Model 1223
20 mA Current Loop
Version

Wall-mount
Transformer

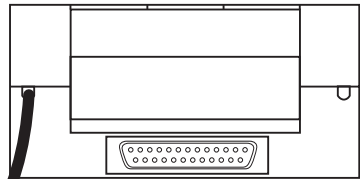
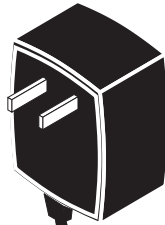

25-pin DB-F Connector

Power Cord

Pin No.	Signal	Direction	Description
1*	Chassis ground	-	Cable shield
23	(RD) Received data(-)	From printer	Printer data return line
25	(RD) Received data(+)	To printer	Printer data input line

*Optional

*The
rest
are not
used.*

Model 1224
RS-485 Serial Version

Wall-mount
Transformer

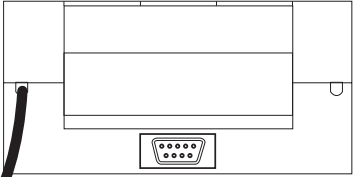
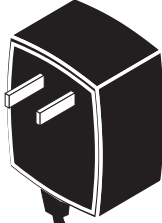

9-pin DB-M Connector

Power Cord

Pin No.	Signal	DTE Direction	Description
2	TXD -	From printer	Printer data output line
6	TXD +		
3	RXD -	To printer	Printer data input line
8	RXD +		

*The
rest
are not
used.*

Serial Connector Pin Arrangement

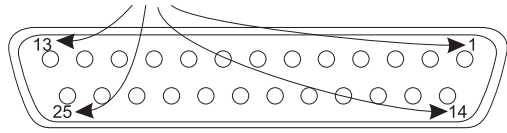

1. Connectors

On the printer: 25-hole receptacle, equivalent to DB-25S

On the cable: 25-pin plug, equivalent to DB-25P

2. Cable

Use cable less than 2500 feet long. A shielded cable using twisted pair conductors is desirable.

CONTROL CODES

According to the American Standard Code of Information Interchange (ASCII), there are 32 control codes in addition to the codes for the printable characters. (Control codes are sent as data, but the receiving device interprets them as abbreviated "instructions", communication - status messages, etc.)

The printer recognizes these control codes:

Function	Abbreviation	Code	
		Hex	Decimal
-	NUL	00	0
-	SOH	01	1
Reserved	STX	02	2
Reserved	ETX	03	3
-	EOT	04	4
-	ENQ	05	5
Reserved	ACK	06	6
-	BEL	07	7
Back Space	BS	08	8
-	HT	09	9
Line Feed	LF	0A	10
-	VT	0B	11
-	FF	0C	12
Carriage Return	CR	0D	13
Double Height	SO	0E	14
Double Width	SI	0F	15
Reset Seq. # to 0000	DLE	10	16
Inhibit Line Space	DC1	11	17
Dot Graphics	DC2	12	18
User Character	DC3	13	19
Set Time & Date	DC4	14	20
Reserved	NAK	15	21
Get time and date	SYN	16	22
-	ETB	17	23
Stop Reverse Field	CAN	18	24
Reverse Field	EM	19	25
Escape	ESC	1B	27
-	FS	1C	28
24 Column Mode	GS	1D	29
32 Column Mode	RS	1E	30
40 Column Mode	US	1F	31

The printer will ignore all other control codes.

Back Space Code 8	Upon receipt of this code, the printer erases from its buffer the previously received character. This is useful in correcting typing errors for programs that send data both to a video screen and the hardcopy printer. Remember that if you type more characters than the printer can print on a line, the printer will automatically start printing.
Line Feed Code 10	The printer handles this control code in exactly the same manner as carriage return (control code 13) except when a line feed immediately follows a carriage return. The line feed code is ignored if it is immediately preceded by a carriage return. The default setting is 7.6 lines per inch.
Carriage Return Code 13	Whenever a carriage return code is received, the printer will print out the current contents of its buffer, then clear the buffer to get ready for additional data.
Double Height Code 14	This control code tells the printer to switch to the double height character line. The control code can be sent at any time on a line; it need not be the first code received by the printer after a carriage return.
Double Width Code 15	<p data-bbox="373 751 966 979">You cannot mix normal and double height characters on the same line. Once you select the double height, the printer will remain in that mode until it receives a carriage return or line feed. A line print caused by a buffer full condition will not clear the double height command. This means that the "wrap around" print line will also be double height if the double height command was sent before the line buffer was filled.</p> <p data-bbox="373 995 966 1393">This control code tells the printer to switch to double width character printing. The control code should be sent as the first character on a line. If it is received after half the maximum characters per line were sent then the printer will ignore all characters on the last half of the line. You cannot mix normal and double width characters on the same line. Once you select the double width, the printer will remain in that mode until it receives a carriage return or line feed. A line print caused by a buffer full condition will not clear the double width command. This means that the "wrap around" print line will also be double width if the double width command was sent before the line buffer was filled.</p>

Enlarged Printing
Codes 14 and 15

Enlarged printing may be selected by sending both the double height command (control code 14) and the double width command (control code 15). The control codes may be sent in either order, but because of the double width restrictions, the codes should be sent at the beginning of a line.

Example of Control Codes 14 and 15:



When the printer receives this control code it will immediately reset the sequence number to 00000.

Reset Sequence Number
Code 16

Inhibit Line Spacing
Code 17

A standard character line is made up of ten dot lines. Eight of these dot lines are used for the printable character and two are used for space between lines. When using character graphics it is desirable to eliminate the two blank lines so the graphic characters connect together. Sending a CHR\$(17) (control code 17) anywhere on a line of data will stop the printer from putting space between that line and the next. If a CHR\$(17) is not on a print line, the normal space between lines will be printed.

Example:

```
10 B$=CHR$(17)
20 LPRINT " "
30 LPRINT " | "B$
40 LPRINT " | "B$
50 LPRINT " | "B$
60 LPRINT " | "B$
```

Run:



Dot Graphics
Code 18

The mechanism used in the printer prints one line of dots across at a time. This means that when it prints one line of characters it has actually printed ten lines of dots where the first eight lines make up the character and the last two lines are blank for the space between character lines. By using the CHR\$(18) control code, you can tell the printer which dots to print for one whole dot line. Since there are 144 dots per line, you must follow the CHR\$(18) control code with 144 bits of information. For every place there is a one in the 144 bit pattern you send, the printer will print a dot. Rather than receive one bit at a time the printer expects to receive the information eight bits at a time. This means that after receiving a CHR\$(18) the next eighteen 8 bit characters it receives will be printed as dots to form one dot line.

To figure out the dot pattern values to send after the CHR\$(18), you will need some grid paper. A large sheet with 144 grid boxes across would be convenient. If such a large sheet of paper is not available, you could divide your pattern in half and work with 72 grid boxes across. Divide up your grid paper by drawing a heavy line down every 8 boxes across. Now fill in each box of the grid that you want to be printed. Now do the following procedure to compute the eighteen values which describe your desired bit pattern.

Imagine placing the number sequence over each of the first eight grid boxes.

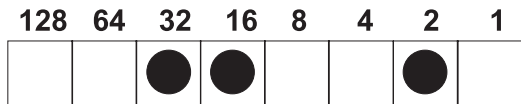

Now add together all the numbers above the boxes which are filled in or have a dot as in the example above. In our example, we would have $2 + 16 + 32$ which equals 50. '50' then would be the first entry of a data statement which would be followed by seventeen more numbers computed in the exact same manner as the example. Once you have the eighteen values in a data statement, you need simply run a program which prints a CHR\$(18) followed by the data value read from the data statement. Don't forget to end all of your print statements with semicolon. This will prevent carriage returns CHR\$(13) from being sent, which would become part of the eighteen data values for which the printer is waiting.

Example 1:

```

3000 REM PRINT DIAGONAL PATTERN
3010 B=1
3020 A$=CHR$(18)
3030 FOR I=1 TO 18
3040 A$=A$+CHR$(B)
3050 NEXT I
3060 LPRINTA$;
3070 B=B+B
3080 IF B>255 THEN B=B-255
3090 GOTO 3020
3100 END

```

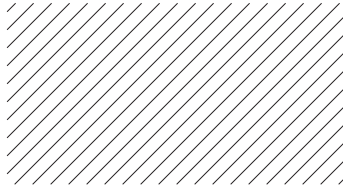

Example 2:

```

4000 REM PRINT BIT-MAPPED
4010 LPRINT
4020 FOR J=1 TO 13
4030 A$=CHR$(18)
4040 FOR I=1 TO 18
4050 READ B;
4060 A$=A$+CHR$(B);
4070 NEXT I
4080 LPRINT A$;
4090 NEXT J
4110 LPRINT
4120 END
4200 DATA 46,0,0,102,48,0,0,0,0,
16,1,128,0,0,0,0,0
4210 DATA 113,0,64,153,72,0,0,0,
0,16,2,64,0,0,2,0,0,0
4220 DATA 160,128,64,16,132,0,0,
0,0,16,2,64,0,0,2,0,0,0
4230 DATA 32,128,224,16,132,0,0,
0,0,16,1,136,0,0,2,2,0,0
4240 DATA 35,8,64,16,132,48,88,8
8,48,16,0,249,1,130,194,0,8,16

```

```

4250 DATA 32,128,67,144,132,72,1
00,100,72,112,0,137,194,67,34,1
92,20,40
4260 DATA 32,64,64,16,132,132,66
,66,72,144,1,9,36,34,19,34,34,6
8
4270 DATA 32,72,64,16,132,132,66
,66,73,16,10,17,36,34,18,34,32
132
4280 DATA 48,72,66,16,132,132,22
8,228,49,18,7,253,36,39,38,37,3
3,69
4290 DATA 40,148,164,16,133,77,9
1,90,83,50,10,33,42,106,218,41,
82,38
4300 DATA 39,99,24,16,130,50,64,
65,140,232,17,198,17,146,2,16,1
4,24
4310 DATA 0,0,0,0,0,0,64,64,0,0,
0,0,0,2,0,0,0,0
4320 DATA 0,0,0,0,0,0,64,64,0,0,
0,0,0,2,0,0,0,0

```

User Programmable Character Code 19

By using CHR\$(19) you enter the Custom Character mode. This allows you to design and print your own 6 x 8 character by inputting data. A data statement is made of numbers that represent a row of dots when read all together, will make up your character. To design your character, follow the example below. You should notice that each number in the data statement corresponds to one row in your character. To design a character, follow these steps:

1. Use quad ruled paper to design your character.
2. Number 8 consecutive rows like this:

1
2
4
8
16
32
64
128

3. Now design your character in dot form (see the example below).
4. Add together all the numbers from the column on the left, counting only where you have placed a dot in a row. In our example, the first column has three dots located in rows 4, 8, and 16. Added together they equal 28.
5. Put your final total for each column into a data statement in column order.

1			●	●		
2		●			●	●
4	●				●	
8	●					
16	●				●	
32		●			●	●
64			●	●		
128						
	28	34	65	65	54	34
	TOTAL					

The data statement in your program will read:
DATA 28, 34, 65, 65, 54, 34

The next step is to tell the printer your newly designed character. To do this you must send a CHR\$(19) followed by the six numbers you computed above. Following is an example of how this can be done.

```

10 DATA28,34,65,65,54,34
20 LPRINT CHR$(19);
30 FOR I=1 TO 6
40 READ A
50 LPRINT CHR$(A);
60 NEXT I
70 LPRINT "This is the programmed"
80 LPRINT "character "CHR $(126)".
90 END

```

This is the programmed character C.

After typing RUN, your custom character will be stored in the printer's memory. It will retain this information until the printer is switched off or until you write over the data by defining a different character.

To print your newly designed character, simply send CHR\$(126) which corresponds to hexadecimal value 7E.

**Set Time and Date
Control Code 20**

This control code is used when setting the printer's time and date clock. Following is the text string to send when setting the clock:

YYMMDDHHMM
 year, month, day 24 hour time day of week (Sunday=1)

**Read Time and Date
Control Code 22**

This control code is used to read the printer's time and date clock. Following is the ASCII string received:

YYMMDDHHMM
 year, month, day 24 hour time day of week (Sunday=1)

**Cancel Reverse Field
Control Code 24**

Sending this control code will turn off the reverse field mode that is selected using control code 25.

**Reverse Field Control
Code 25**

Send this control code to turn on the reverse field printing mode. This will print white letters on a dark background. Do not print more than three reverse field print lines. Also, do not print more than a few empty spaces in a reverse field. The printer may become overloaded and stop printing.

Selectable Column Width
Codes 29, 30, 31

The printer powers up in the column mode last selected by configuration. You can change the column width by sending the appropriate control code from the list below:

- Control code 29 - 24 columns
- Control code 30 - 32 columns
- Control code 31 - 40 columns

You can send the control code at any point on a line before the buffer becomes filled. You cannot change column widths on the same line.

Printable Characters

The Model 122X printer can produce all ASCII characters from hex 20 through hex 7D (decimal 32 through 125). Here's what they look like:



Note the last two codes of the usual ASCII character set are not supported. Instead, if CHR\$(126), which corresponds to hexadecimal 7E, is received by the 122X printer, it will print the character defined in its RAM (Random Access Memory). The section on USER Programmable Character describes how this RAM can be loaded with any 6 x 8 pattern.

The model 122X also has a graphic character set that resides between hexadecimal values 80 and FF (decimal 128 and 255). The symbols used are compatible with Radio Shack® Model 100 portable computer.

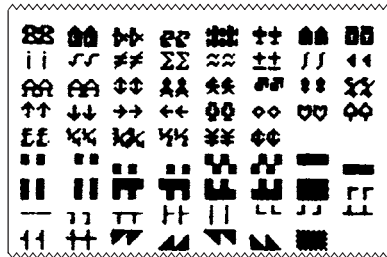

For special applications please contact our Customer Service Department for further assistance:

Phone 800-982-6622
707-527-5555
Fax 800-847-6743
707-579-0180

Printer Escape Command
Code Definitions

Command Print formatted data

<ESC> 0	HH:MM	24 hour format
<ESC> 1	HH:MM_?M	12 hour format with AM or PM
<ESC> 2	MM/DD/YY	month/day/year
<ESC> 3	DD-MM-YY	day-month-year/ numeric month
<ESC> 4	DD-MON-YY	day-month-year with 3 letter abbreviation of the month
<ESC> 5	DOW	day of week abbreviation
<ESC> 6		currently configured format
<ESC> 9	XXXX	current sequence number

Default Table

Below is a table showing the possible values for the Custom and Configuration menu parameters. The values shown in **bold** type are the default settings.

Custom Menu		Configuration Menu	
T/D Format	1 - None 2 - MM/DD/YY_hh:mm_?M 3 - MM/DD/YY hh:mm ?M DOW 4 - MM/DD/YY hh:mm 5 - MM/DD/YY hh:mm DOW 6 - DD-MM-YY hh:mm ?M 7 - DD-MM-YY hh:mm ?M DOW 8 - DD-MM-YY hh:mm 9 - DD-MM-YY hh:mm DOW 10 - DD-MON-YY hh:mm ?M 11 - DD-MON-YY hh:mm ?M DOW 12 - DD-MON-YY hh:mm 13 - DD-MON-YY hh:mm DOW	Baud	1 - 300 2 - 600 3 - 1200 4 - 2400 5 - 4800 6 - 9600 7 - 19200
Auto T&D	1 - NO (no print after CR) 2 - YES (print after CR)	Data Bits	1 - 7 2 - 8
Auto SEQ#	1 - NO (no print after CR) 2 - YES (print after CR)	Parity	1 - ODD (none if data bits = 8) 2 - EVEN (none if data bits = 8)
Zero	1 - Ø Zero with slash 2 - 0 Zero without slash	Stop Bits	1 - 1 2 - 2
Pound symbol	1 - # U.S. pound symbol 2 - £ British pound sterling	Handshake	1 - None 2 - BUSY-LINE (serial only) 3 - BUSY-BUFF (serial only) 4 - XON/XOFF-LINE (serial only) 5 - XON/XOFF-BUFF(serial only)
Underscore	1 - _ Underscore 2 - ← Left arrow	Columns	1 - 24 2 - 32 3 - 40
Busy Invert	1 - Non-inverted busy (CTS) 2 - Inverted busy	Inver	1 - No (non-inverted printing) 2 - YES (inverted printing)
Online/Offline	1 - switch function enabled 2 - switch function disabled	Font Type	1 - 5x8 font 2 - 5x5 font
Ext Ch Set	1 - NO (no extended char. set) 2 - YES	Magnification	1 - No magnification 2 - Double width 3 - Double height 4 - Double width, double height
Print Ready	1 - Print "Ready" message 2 - Don't print "Ready" message		

Avery Weigh-Tronix

Avery Weigh-Tronix USA

1000 Armstrong Dr.
Fairmont, MN 56031 USA
Telephone: 507-238-4461
Facsimile: 507-238-4195
e-mail: industrial@weigh-tronix.com
www.wtxweb.com

Avery Weigh-Tronix UK

Foundry Lane
Smethwick, West Midlands
England B66 2LP
Tel: +44 870 90 34343
Fax: +44 121 224 8183
Email: info@awtxglobal.com
Web site: www.averyweigh-tronix.com

Avery Weigh-Tronix Canada, ULC

217 Brunswick Boulevard
Pointe Claire, QC H9R 4R7 Canada
Telephone: 514-695-0380
Toll free: 800-561-9461
Facsimile: 514-695-6820
www.weigh-tronix.ca

